

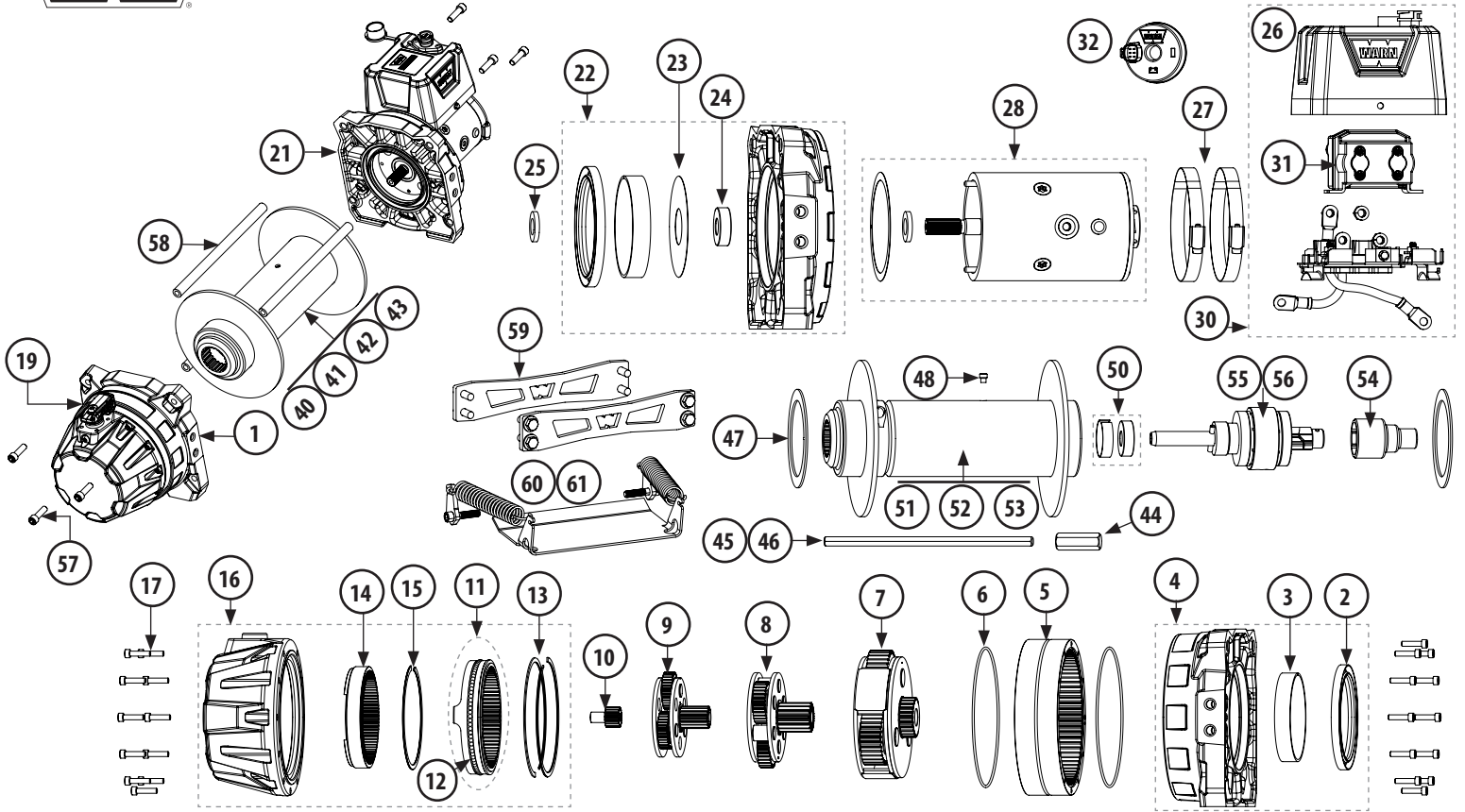

SERIES G2 9 ELECTRIC WINCH REPLACEMENT PART LIST



TRANSMISSION GROUP					
Winch Motor Type:		12V	24V		
KIT#	Description	PN	PN		
1	Full Transmission Assembly	104549	104549		
2	Seal Replacement Part	107033	107033		
3	Bushing Replacement Kit	107030	107030		
4	Transmission Drum Support Replacement	107025	107025		
5	Ring Gear (Stage 3)	104555	104555		
6	O-ring Replacement Kit	107031	107031		
7	Carrier Assembly (Stage 3)	98769	98769		
8	Carrier Assembly (Stage 2)	98766	98766		
9	Carrier Assembly (Stage 1)	104563	104563		
10	Sun Gear	104566	104566		
11	Rotating Ring Gear (Stage 2) Replacement Kit	107034	107034		
12	Ball Bearing Replacement Kit	22350	22350		
13	Ret. Ring (Stage 2) Replacement	98485	98485		
14	Ring Gear (Stage 1)	107029	107029		
15	Ret. Ring (Stage 1) Replacement	107028	107028		
16	End Housing Replacement	107027	107027		
17	Transmission Fastener Kit	107032	107032		
18	Clutch Lever Hardware Replacement Kit	107035	107035		
Clutch Type:		Manual	Remote	Air	Plugged
KIT#	Description	PN	PN	PN	PN
19	Clutch Replacement	107036	107037	107038	107039
20	Clutch Extension Kit for Remote Clutch Lever	-	107040	-	-

MOTOR GROUP					
Winch Motor Type:		12V	24V		
KIT#	Description	PN	PN		
21	Motor and Drum Support Assembly	104557	104559		
22	Motor Drum Support Replacement	107046	107046		
23	Dust Mask Replacement	107047	107047		
24	Motor Bearing Replacement	98499	98499		
25	Motor Shaft Spacer Replacement	99694	99694		
26	Control Pack Cover Replacement	104629	104629		
27	Control Pack Clamp Replacement Kit	102088	102088		
28	Motor Replacement	104560	107048		
29	Generic Nameplate Label Replacement	104666	104667		
30	Control Pack Replacement	107049	107050		
31	Contactor Replacement	98381	107051		
32	OLI Module Replacement	105047	105023		
-	OLI Wire Kit	104542	104542		
-	OLI Harness ONLY	108127	108127		
Remote Control Length:		12ft.	10m		
33	Remote Control	88528	88527		
GENERAL COMPONENTS					
KIT#	Description	PN			
34	General Winch Label Replacement Kit	107121			
35	Mounting Hardware Replacement Kit	107120			
36	Winch Hook - Standard	98389			
37	Winch Hook - 5 Ton	77681			
Drum Length:		6.5"	8"	10"	12.5"
38	Roller Fairlead	29844	24335	24336	107199
39	Hawse Fairlead	107200	107201	107202	107203

DRUM GROUP					
Drum Length:		6.5"	8"	10"	12.5"
KIT#	Description	PN	PN	PN	PN
40	Drum & Brake Assembly (Wire Rope) Anti-Clockwise Drum Rotation	107078	107082	107086	107090
41	Drum & Brake Assembly (Wire Rope) Clockwise Drum Rotation	107079	107083	107087	107091
42	Drum & Brake Assembly (Synthetic Rope) Anti-Clockwise Drum Rotation	107080	107084	107088	107092
43	Drum & Brake Assembly (Synthetic Rope) Clockwise Drum Rotation	107081	107085	107089	107093
44	Electric Drive Shaft Brake Adapter	98525	98525	98525	98525
45	Drive Shaft (9/12 Capacity)	107058	107058	107059	107059
46	Drive Shaft (15/18 Capacity)	107060	107060	107061	107061
47	Thrust Washer Replacement Kit	98372	98372	98372	98372
48	Drum Set Screw Replacement	98534	98534	98534	98534
49	Synthetic Rope Fastener Kit	107115	107115	107115	107115
50	Drum Bearing and Tolerance Ring Kit	31672	31672	31672	31672
51	Wire Rope Drum Replacement	106272	32057	31671	32225

DRUM GROUP					
Drum Length:		6.5"	8"	10"	12.5"
KIT#	Description	PN	PN	PN	PN
52	Synthetic Rope Drum Replacement Anti-Clockwise Drum Rotation	107062	107063	107064	107065
53	Synthetic Rope Drum Replacement Clockwise Drum Rotation	107066	107067	107068	107069
54	Brake Driver Replacement	77717	77717	77717	77717
55	Brake Assembly Service Kit Anti-Clockwise Drum Rotation	107094	31683	31683	107097
56	Brake Assembly Service Kit Clockwise Drum Rotation	107095	107096	107096	107098
57	Tie Rod Fastener Replacement Kit	107114	107114	107114	107114
58	Tie Rod Replacement Kit	107099	98502	98355	98386
59	Tie Bar Replacement Kit	107100	107101	107102	107103
60	Tensioner Kit - Side Mounted	107104	107105	107106	107107
61	Tensioner Kit - Top Mounted	107108	107109	107110	107111



SERIES G2 9 HYDRAULIC WINCH REPLACEMENT PART LIST

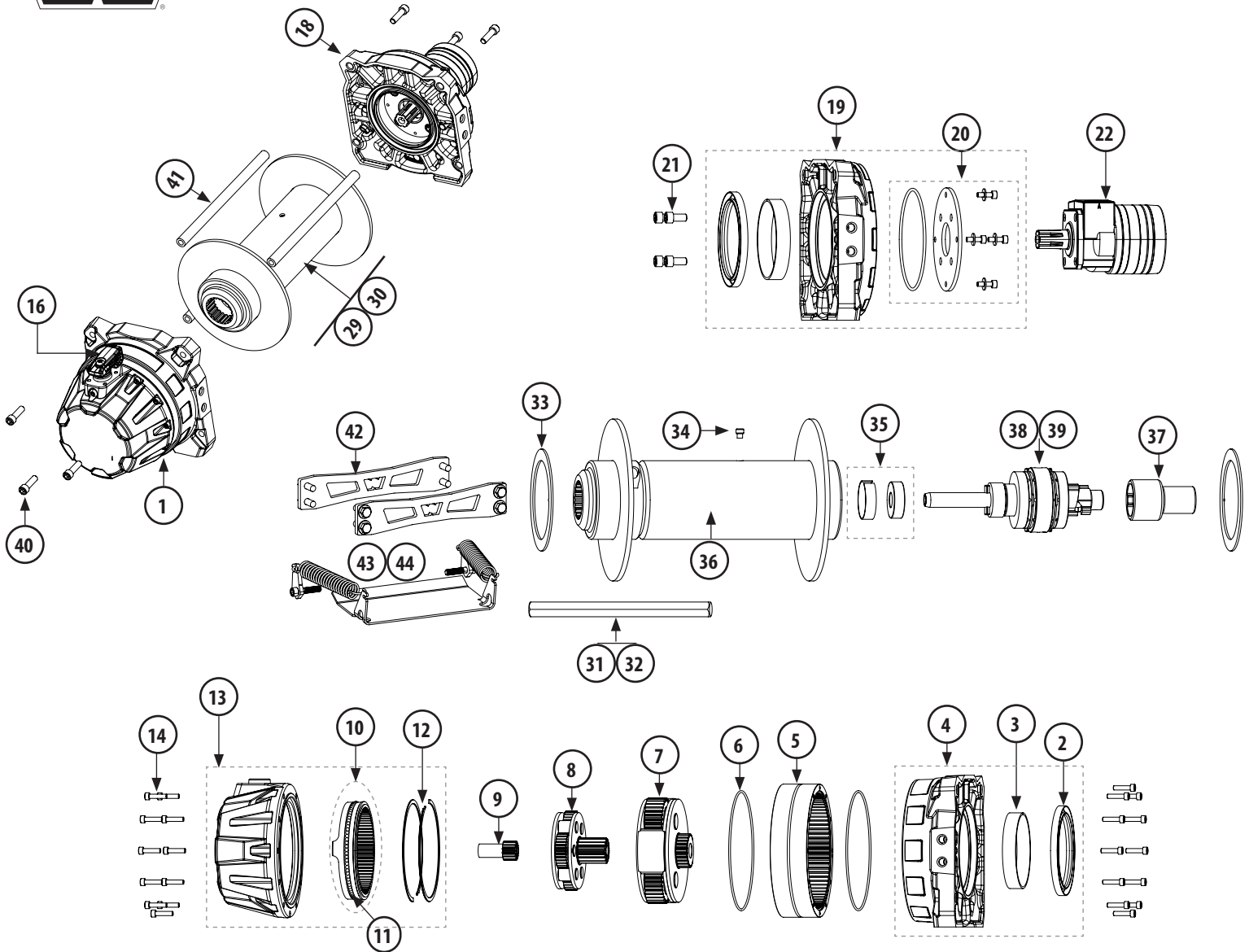

TRANSMISSION GROUP					
Winch Motor Type:		HS	LP		
KIT#	Description	PN	PN	PN	
1	Full Transmission Assembly	104553	104553	104553	
2	Seal Replacement	107033	107033	107033	
3	Bushing Replacement Kit	107030	107030	107030	
4	Transmission Drum Support Replacement	107025	107025	107025	
5	Ring Gear Replacement (Stage 3)	104555	104555	104555	
6	O-ring Replacement Kit	107031	107031	107031	
7	Carrier Replacement (Stage 3)	102553	102553	102553	
8	Carrier Replacement (Stage 2)	98766	98766	98766	
9	Sun Gear	98508	98508	98508	
10	Rotating Ring Gear (Stage 2) Kit	107034	107034	107034	
11	Ball Bearing Replacement Kit	22350	22350	22350	
12	Ret. Ring (Stage 2) Replacement Kit	98485	98485	98485	
13	End Housing Replacement	107026	107026	107026	
14	Transmission Fastener Kit	107032	107032	107032	
15	Clutch Lever Hardware Kit	107035	107035	107035	
Clutch Type:		Manual	Remote	Air	Plugged
KIT#	Description	PN	PN	PN	PN
16	Clutch Replacement	107036	107037	107038	107039
17	Clutch Extension Kit for Remote Clutch Lever	-	107040	-	-

MOTOR GROUP			
Winch Motor Type:		HS	LP
KIT#	Description	PN	PN
18	Motor and Drum Support Assembly	104569	104570
19	Motor Drum Support Replacement	107045	107045
20	Motor Mounting Plate Kit	107052	107052
21	Motor Mounting Fastener Kit	98483	98483
22	Motor Replacement	104574	104575
23	Generic Nameplate Label Replacement	104537	104607

GENERAL COMPONENTS					
KIT#	Description	PN			
24	General Winch Label Replacement Kit	107121			
25	Mounting Hardware Replacement Kit	107120			
26	Winch Hook - Standard	98389			
27	Winch Hook - 5 Ton	77681			
Drum Length:		6.5"	8"	10"	12.5"
28	Roller Fairlead	29844	24335	24336	107199

DRUM GROUP					
Drum Length:		6.5"	8"	10"	12.5"
KIT#	Description	PN	PN	PN	PN
29	Drum and Brake Assembly Anti-Clockwise Drum Rotation	107070	107072	107074	107076
30	Drum and Brake Assembly Clockwise Drum Rotation	107071	107073	107075	107077
31	Drive Shaft (9/12 Capacity)	107055	107055	102552	102552
32	Drive Shaft (15/18 Capacity)	107056	107056	107057	107057
33	Thrust Washer Kit	98372	98372	98372	98372
34	Drum Set Screw Replacement	98534	98534	98534	98534
35	Drum Bearing and Tolerance Ring Kit	31672	31672	31672	31672
36	Wire Rope Drum Replacement	106272	32057	31671	32225

DRUM GROUP					
Drum Length:		6.5"	8"	10"	12.5"
KIT#	Description	PN	PN	PN	PN
37	Brake Driver Replacement	102555	102555	102555	102555
38	Brake Assembly Service Kit (Anti-Clockwise Drum Rotation)	107112	87858	87858	88058
39	Brake Assembly Service Kit (Clockwise Drum Rotation)	107113	87860	87860	88059
40	Tie Rod Fastener Kit	107114	107114	107114	107114
41	Tie Rod Replacement Kit	107099	98502	98355	98386
42	Tie Bar Replacement Kit	107100	107101	107102	107103
43	Tensioner Kit - Side Mounted	107104	107105	107106	107107
44	Tensioner Kit - Top Mounted	107108	107109	107110	107111